

Uni-COM™ CX Modules

Installation Guide

UAC-CX-01RS2,
UAC-CX-01RS4,
UAC-CX-01CAN



This guide provides basic installation information for Unitronics' Uni-COM™ CX Modules. Use them to add communication ports to specific models of the UniStream® family of Programmable Logic Controllers. Compatible models comprise a Uni-COM™ CX Module Jack which provides the connection point for the module.

Refer to the specifications of your UniStream model to check whether it is compatible with CX modules.

UAC-CX-01RS2 offers one RS232 port, UAC-CX-01RS4 offers one RS485 port, and UAC-CX-01CAN offers one CANbus port.

Technical specifications and Installation Guides are available in Unitronics Technical Library at www.unitronicsplc.com.



Before You Begin

Before installing the device, the installer must:

- Read and understand this document.
- Verify the Kit Contents.

Alert Symbols and General Restrictions

When any of the following symbols appear, read the associated information carefully.

Symbol	Meaning	Description
	<i>Danger</i>	<i>The identified danger causes physical and property damage.</i>
	<i>Warning</i>	<i>The identified danger could cause physical and property damage.</i>
<i>Caution</i>	<i>Caution</i>	<i>Use caution.</i>

- All examples and diagrams are intended to aid understanding, and do not guarantee operation. Unitronics accepts no responsibility for actual use of this product based on these examples.
- Please dispose of this product according to local and national standards and regulations.
- This product should be installed only by qualified personnel.

-  Failure to comply with appropriate safety guidelines can cause severe injury or property damage.
- Do not attempt to use this device with parameters that exceed permissible levels.
- Do not connect/disconnect the device when power is on.

Environmental Considerations



- Ventilation: 10mm (0.4") of space is required between the device top/bottom edges and the enclosure's walls.
- Do not install in areas with: excessive or conductive dust, corrosive or flammable gas, moisture or rain, excessive heat, regular impact shocks or excessive vibration, in accordance with the standards and limitations given in the product's technical specification sheet.
- Do not place in water or let water leak onto the unit.
- Do not allow debris to fall inside the unit during installation.
- Install at maximum distance from high-voltage cables and power equipment.

Kit Contents

UAC-CX-01RS2

- 1 UAC-CX-01RS2 module

UAC-CX-01RS4

- 1 UAC-CX-01RS4 module
- 1 RS485 terminal block

UAC-CX-01CAN

- 1 UAC-CX-01CAN module
- 1 CANbus terminal block
- 1 CANbus termination resistor

Uni-COM™ CX Diagram

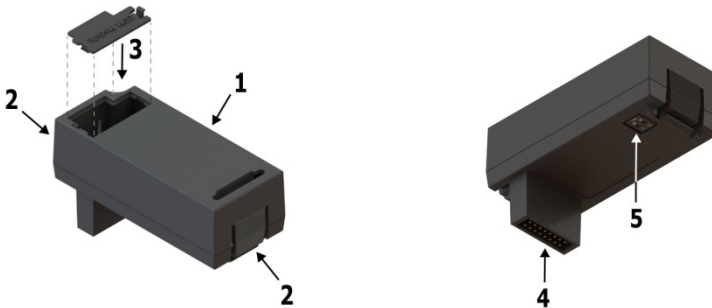

1	Port	The type of port depends upon the module
2	Clips, Top and Bottom	The clips secure the module when it is snapped into place
3	COM Module Jack and cover	This is the connection point for a stack-on module, shipped covered. Leave covered when not in use.
4	Connection plug	Plug this into the COM module jack
5	DIP switch UAC-CX-01RS4 only	RS485 termination selection DIP switch

Installation



- Turn off system power before connecting or disconnecting any module or device.
- Use proper precautions to prevent Electro-Static Discharge (ESD).
- The module is shipped with its COM module jack covered. To protect the jack from debris, damage, and ESD, you must leave it covered when not in use.
- The final module in a stack must have its jack covered.

NOTE

- UAC-CX modules can only be installed on the back of compatible UniStream™ controllers.
- UAC-CX modules may be installed in the following configurations:
 - If a module comprising a serial port is snapped directly into to the back of UniStream™, it may be followed **only** by another serial module, for a total of 2.
 - If your configuration includes a CANbus module, it must be snapped directly to the back of UniStream. The CANbus module may be followed by up to two serial modules, for a total of 3.

Installing a UAC-CX Module

Snapping the first module to the back of the controller:

1. Check the controller to verify that its COM jack is not covered.
If the UAC-CX module is to be the last one in the configuration, do not remove the cover of its COM jack.
2. Insert the module's connection plug into jack until it is firmly seated.

Stacking additional modules onto the first:

1. Check the module that is already installed to verify that its COM jack is not covered.
If the UAC-CX module is to be the last one in the configuration, do not remove the cover of its COM jack.
2. Insert the module's connection plug into jack until it is firmly seated.



Removing a Module

You must remove the end module in a stack before removing the next one.

1. Turn off the system power.
2. Disconnect any wires or cables connected to the module.
3. Press the clips on the top and bottom of the modules, and carefully pull the module from its place.

NOTE

If you are removing the module that is plugged into the controller, note that if an I/O Expansion Base Unit is plugged into the I/O Expansion Jack, you will have to remove the Base Unit in order to access the clips.

Wiring



- All wiring activities should be performed while power is OFF.
- Unused points should not be connected (unless otherwise specified). Ignoring this directive may damage the device.
- Double-check all wiring before turning on the power supply.

Caution

- To avoid damaging the wire, use a maximum torque of 0.5 N·m (5 kgf·cm).
- Do not use tin, solder, or any substance on stripped wire that might cause the wire strand to break.
- Install at maximum distance from high-voltage cables and power equipment.

Wiring Procedures

UAC-CX-01RS4, UAC-CX-01CAN - RS485/CANbus terminal block

Use crimp terminals for wiring; use 26-12 AWG wire (0.13 mm² –3.31 mm²).

1. Strip the wire to a length of 7±0.5mm (0.275±0.020 inches).
2. Unscrew the terminal to its widest position before inserting a wire.
3. Insert the wire completely into the terminal to ensure a proper connection.
4. Tighten enough to keep the wire from pulling free.

Wiring Guidelines

In order to ensure that the device will operate properly and to avoid electromagnetic interference:

- Use a metal cabinet. Make sure the cabinet and its doors are properly earthed.
- Use shielded cables.

NOTE For detailed information on avoiding EMI, refer to the document System Wiring Guidelines, located in the Technical Library in the Unitronics' website.



-Turn off power before making any communications connections.

UAC-CX-01RS2 - RS232 module

- Use shielded cable

Pin Number	Pin Name	Direction	Description
1	-	-	Not connected
2	RXD	In	Receive Data
3	TXD	Out	Transmit Data
4	-	-	Not connected
5	SG	Return	Signal Ground
6 (see note)	-	-	Connected to Pin 7
7 (see note)	-	-	Connected to Pin 6
8, 9	-	-	Not connected

NOTE Pins 6 and 7 are not connected to internal circuits.

UAC-CX-01RS4 – RS485 module

Use the RS485 port to create a multi-drop network.

The UAC-CX-01RS4 is shipped with a 4 pin RS485 terminal block. This connector is marked with a pin assignment that is identical to the corresponding marking on the module.

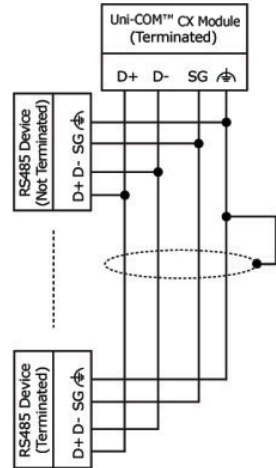

RS485 Wiring

D+	Tx/Rx+ (B)
D-	Tx/Rx- (A)
SG	Signal Ground
	Functional Ground



- Use shielded twisted-pair cable, in compliance with EIA RS485 specifications.
- When wiring each node, connect the cable shield to the functional ground point of the RS485 terminal block.

Caution In order to avoid ground-loops, do not connect the RS485 functional ground terminal to the earth of the system, as it is internally connected to the controller's functional ground point.

RS485 Termination

Use the DIP switches shown in the Uni-COM diagram on page 2 to set the RS485 termination according to the accompanying table.

The device is shipped with both its DIP switches set to ON; change settings if the device is not at one of the ends of the RS485 network.

Position		DIP Switch State
1	2	
ON	ON	Terminated (factory default)
OFF	OFF	Not Terminated

UAC-CX-01CAN - CANbus module

Use the CANbus port for all CANbus communications including integration of Remote I/Os via EX-RC1.

CANbus Wiring

- +V CANbus Power Supply (see Note)
- H CAN High
-  Functional Ground
- L CAN Low
- V CANbus Power & Signal Common

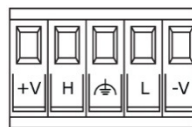

- Use a shielded twisted-pair cable. DeviceNet[®], shielded twisted-pair cable is recommended.
- When wiring each node, connect the cable shield to the functional ground point of the CANbus terminal block.
- Connect the CANbus cable shield to the system earth at only one point near the power supply.

DeviceNet[®] cable connection:

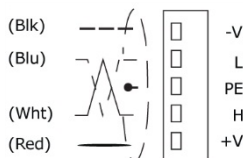

NOTE The Uni-COM[™] CANbus port is internally powered and does not require an external power-supply. This means that you can either connect the +V point in the CPU's CANbus connector to an external power supply, or leave it unconnected.

Do not use the +V point for any other purpose.

CANbus Termination

Place termination resistors at each end of the CANbus network. Resistance must be set to 121Ω, 1/4W, 1%.

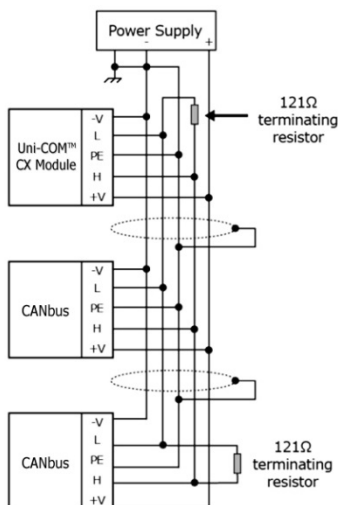

The information in this document reflects products at the date of printing. Unitorics reserves the right, subject to all applicable laws, at any time, at its sole discretion, and without notice, to discontinue or change the features, designs, materials and other specifications of its products, and to either permanently or temporarily withdraw any of the foregoing from the market.

All information in this document is provided "as is" without warranty of any kind, either expressed or implied, including but not limited to any implied warranties of merchantability, fitness for a particular purpose, or non-infringement. Unitorics assumes no responsibility for errors or omissions in the information presented in this document. In no event shall Unitorics be liable for any special, incidental, indirect or consequential damages of any kind, or any damages whatsoever arising out of or in connection with the use or performance of this information.

The tradenames, trademarks, logos and service marks presented in this document, including their design, are the property of Unitorics (1989) (R'G) Ltd. or other third parties and you are not permitted to use them without the prior written consent of Unitorics or such third party as may own them.